



# WaterRower A1



OWNER'S MANUAL  
ASSEMBLY INSTRUCTIONS  
MONITOR INSTRUCTIONS  
WARRANTY & CONTACT INFO



## TABLE OF CONTENTS

---

Owner's Manual	03 – 09
Assembly Instructions	12 – 19
Monitor Instructions	21 – 24
Warranty Information / Troubleshooting	25 – 26



### INTRODUCTION

---

Congratulations on becoming a WaterRower owner.

Rowing is universally recognized as the perfect aerobic exercise – smooth, low impact, rhythmic and whole-body – unrivalled for its physiological benefits and aesthetic pleasures.

“Rowing, indoors or outdoors, at any exercise level of intensity, requires a greater exercise expenditure than any other aerobic activity. Calories are burned in relation to the number of muscles used and the intensity and duration of the exercise. Rowing with a sliding seat uses a very large muscle mass since the upper, lower and trunk muscles are used vigorously.”

**-Dr. C Everett Koop- Former US Surgeon General**

While most rowing machines imitate the action of rowing, they do so mechanically, and therefore lack the natural dynamics experienced when a boat and crew glide down a river.

At WaterRower, we have focused on replicating the physical dynamics of rowing, with the knowledge that this will achieve all of its physiological benefits, as well as much of the aesthetic pleasure.

To maximize the enjoyment from using your WaterRower we recommend that you follow our suggestions on rowing technique and training programs. We hope that some of the discussion points in this manual will improve your knowledge about exercise in general, so that you are better able to fulfill your specific exercise objectives.

Your WaterRower has been carefully hand-crafted to give you years of trouble-free use. You will notice that each WaterRower is unique due to the variance in color and grain that occurs naturally in genuine hardwood. We recommend that you closely follow the assembly details provided, particularly by assembling the machine in the correct sequence, and adhering to the suggested maintenance schedule.

We hope you enjoy using your WaterRower for many years to come.

## SAFETY

---

We recommend consulting a physician before starting out with an exercise program. Please read all instructions before using the WaterRower. Additional information on getting started, rowing technique and rowing training advice can be found at [www.HowToRow.com](http://www.HowToRow.com).

**⚠ CAUTION:** Please keep hands away from moving parts when rowing machine is in use. Failing to do so can lead to injury. For further information on safety tips, please refer to



[www.waterrower.com/safety](http://www.waterrower.com/safety).

## OPERATION

---

The WaterRower is unique in using the effect of drag to provide an exercise which is entirely self paced. Because drag is linked to speed, a crew rowing down a river chooses its intensity of exercise simply by altering the pace at which they row: the faster the boat travels the greater the drag and the harder the crew must work. There is a similar effect in swimming.

By replicating these dynamics the WaterRower does not require adjustment to increase resistance: if a more intensive workout is required, simply row faster and harder, and the WaterRower will respond accordingly.

## WATER LEVEL

---

The amount of water in the Tank simulates the weight of the Boat and Crew as it glides down the river. Changing the Water Level does not change the resistance, it simply changes the mass which the user is trying to move. Increasing the Water Level simulates a heavier boat and crew mass, similarly reducing the Water Level simulates a lighter boat and crew mass.

The Water Level is adjusted according to one's personal preference or user type; the intensity is altered simply by moving the chosen mass faster or slower. A level gauge is positioned on the bottom of the the tank. Overfilling the tank could impact the warranty coverage. Do not fill above the maximum level.

NOTE - Fill the tank with ordinary municipal water. Municipal water contains additives which will deter the growth of algae. If municipal water is unavailable, use distilled water (do not use well water). Unless using blue dye, add the purification tablet supplied with your WaterRower. (Refer to the section on Preventative Maintenance for advice on Water Treatment).

## FOOTPAD POSITION

---

The Footpad has been designed to be adjusted for maximum comfort. The Footstrap is designed to cross the foot at the pivot point of the toes (the ball of the foot). This should enable the heel to be raised off the Footboard as the user comes forward with each stroke. The Footpad can be easily adjusted to accommodate different users, simply lift the top lip of the Footpad to unhook and slide up or down to reposition on another hole.

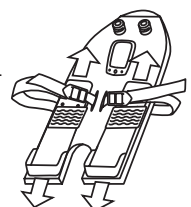

## **START UP MAINTENANCE**

---

During the first weeks of use, the wood in your WaterRower will adjust to the temperature and humidity of the environment. During this period it is strongly advised that you GENTLY tighten all the Connecting Bolts with the Allen Key. Please be careful not to overtighten any of these bolts.

Additionally, as the Drive and Recoil Belts loosen up with use, it may be necessary to tighten the Recoil Belt. To do this, leave the Handle in the full forward position and adjust the Bungee/Recoil Belt Buckle to provide a little more tension. Please refer to 'Adjusting the Recoil' video at: [www.waterrowerservice.com/videos](http://www.waterrowerservice.com/videos).

## **PREVENTATIVE MAINTENANCE**

---

Periodic maintenance is required to maintain the condition of the water in the tank. We strongly ADVISE USING MUNICIPAL TAP WATER which contains other Chemicals to keep it free from Bacteria and Algae, etc. The water must be refreshed periodically by adding a Water Purification Tablet provided. The purification tablet degrades by exposure to light: this may vary from 6 months in direct sunlight to 2 years in an artificially lit environment. On average, add one purification tablet every 6 months.

If water discoloration occurs add a purification tablet immediately. If the water does not clear, we recommend emptying the Tank, flushing it out with clean water, refilling, and adding a purification tablet. NEVER USE POOL CHLORINE OR CHLORINE BLEACH in the Tank as this will irreparably damage the Polycarbonate Tank. The use of an alternative purification option in the tank beyond the approved WaterRower product could void the warranty.

## **MAINTAINING AND CLEANING**

---

To maintain the appearance and integrity of your WaterRower it is necessary to keep the machine clean. It is particularly important to ensure that there is no dust build up in the Clutch and Belt Mechanism between the Top and Bottom Decks. Dust can be removed by using a vacuum cleaner.

The surface and groove in the monorail must be kept clean to prevent dust fouling the Seat Wheels, and can be cleaned by wiping with a damp cloth.

The surface of the tank can be cleaned, however, please ensure you read the instructions for any cleaning fluids prior to use.

DO NOT USE METHYLATED SPIRITS, CHLORATES, BLEACH OR AMMONIA BASED FLUIDS when cleaning any part of your WaterRower. The use of improper cleaning products could void the warranty.

## MAINTAINING THE WOOD

---

The natural wood WaterRowers are finished with Danish Oil which gives a deep penetrating finish to the Hardwood Frame. Other than occasional dusting or polishing, the wood requires no maintenance. The use and/or storage of the WaterRower in inclement weather, including but not limited, to extreme temperatures and moisture could void the warranty.

## STORAGE OF YOUR WATERROWER

---

Your WaterRower can be stored upright. Lift the Rear Leg end, pull the WaterRower towards you and use the momentum to stand it in an upright position. When storing the WaterRower, please ensure the seat is in the forward position (close to the footboard). When stored upright the WaterRower is stable and it only takes the space of a chair.

## STARTING OUT WITH ROWING

---

Rowing is an endurance sport which requires a high level of skill. This skill is based on the co-ordination of the legs (which create the driving force of the rowing action), torso and arms in propelling the boat across the water.

The rowing action is comprised of both fast (drive phase) and slow (recovery phase) movements. Skill is also required in combining these movements into a rhythm in order to create a smooth, flowing, unhurried rowing action. The diagrams below show 3 basic movements of the rowing action.

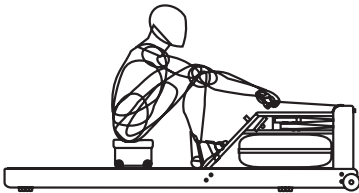

### CATCH POSITION

Sitting tall, arms straight reaching forward, shoulders relaxed, head up, eyes looking forward, legs compressed and shins vertical.

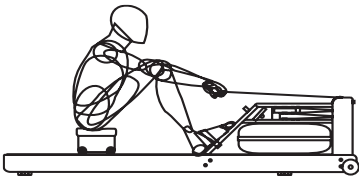

### DRIVE PHASE

Drive back with the legs, arms hang off the handle and only begin to bend once handle is above the knees, torso is strong with good posture and body angle opens up slowly as you drive the legs.

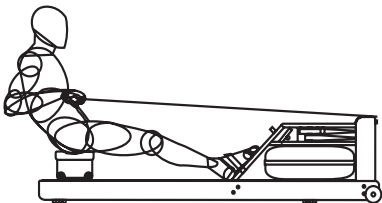

### RELEASE POSITION

Legs straight, handle drawn to chest, sitting back just past the vertical, torso firm, shoulders relaxed, head up and eyes looking forward.

Allow yourself the first few rowing sessions to practice the correct positions and phases as well as the correct ratio and rhythm of the rowing action. With regular rowing, the technique will become easier and you will soon experience the physiological benefits of rowing.

Please visit [www.HowToRow.com](http://www.HowToRow.com) to learn more about the phases and positions of the rowing technique.

## **YOUR EXERCISE PROGRAM**

---

Most of us recognize the benefit of exercise and the potential improvements to our general health and well being. However few of us fully understand the physiology of exercise and the best means of achieving our specific exercise objectives.

In order to get the most out of any exercise program, it is essential to have an understanding of what your exercise objectives are. These may include reducing or maintaining weight, improving general strength, developing bulging muscles, improving sporting competitiveness or simply avoiding the health consequences of a modern sedentary lifestyle.

It is important to set a few different types of objectives.

These are divided into:

- **Immediate Objectives** - weekly
- **Short Term Objectives** - monthly
- **Long Term Objectives** - yearly

Your long term objectives are your final objectives, to achieve these, you need stepping stones which are the short term objectives and immediate objectives. Objectives need to be:

- **Specific** - set goals that you would like to achieve by certain dates
- **Realistic** - do not set a standard too high or motivation will be lost
- **Flexible** - be prepared for set backs such as injuries and illness

Your personal exercise objectives will influence the intensity, duration, frequency and type of exercise you do. Below are a few examples of different exercise objectives:

## **WEIGHT MAINTENANCE**

---

At lower intensities, our body uses a mixture of fat and carbohydrate as its source of fuel. As the maximum aerobic output is approached, the percentage of fat consumed as fuel reduces to zero. Also, as the duration of exercise is increased the percentage of fat consumed tends to increase.

If your objective is weight maintenance, then it is necessary to burn as much fat (as opposed to carbohydrate) as the source of fuel as possible. This is best achieved at lower intensities and over longer durations. As soon as the intensity is increased the aerobic process starts to burn more carbohydrate and less fat. A low intensity (60 - 70% of the maximum heart rate) is typically that at which you can hold a conversation: it is by no means strenuous and is about that achieved by a brisk walk.



## **AEROBIC TRAINING**

---

A sustained exercise program will improve the efficiency with which the respiratory and cardiovascular system can supply oxygen. This improves lung function, heart function, vascular efficiency and capillary growth, leading to improved well being and endurance. At about 70 - 80% of the maximum heart rate, lactate begins to accumulate in the blood supply at a greater rate than it can be extracted by the liver, kidneys and other organs. Exercising above this intensity will cause progressive accumulation of lactate in the blood, increased heart and breathing rates and cause muscle fatigue.

Prolonged exercise at or below this intensity will maintain lactate at non-fatiguing levels and exercise duration will be limited solely to the depletion of available fuel stores.

If your exercise objective is aerobic (cardio-vascular/endurance) training then it is necessary to exercise at an intensity which will avoid fatigue due to lactate build up. This is best achieved at moderate levels of intensity over medium/long durations.

A moderate exercise intensity (70-80% of the maximum heart rate) is about that achieved by a steady jog, avoiding the onset of muscle soreness.

## **ANAEROBIC TRAINING**

---

Anaerobic training causes the build-up of lactate (as rapidly as one minute after exercise is commenced). Lactate saturation will necessitate either a rapid reduction in exercise intensity or complete cessation.

The accumulation of lactate limits the contribution of the anaerobic process to total energy production. Though energy may be generated rapidly, total work capacity and total output is limited.

The level of intensity at which lactate begins to accumulate can be altered by training. This is best done by improving the efficiency of the aerobic process and is achieved by training at moderate levels of intensity.

Training anaerobically is done at high intensities (80-100% of the maximum heart rate) over a short period of time (10 seconds to a few minutes). Interval training is a form of anaerobic training.

## TRAINING GUIDELINES

---

To ensure you get the maximum benefit from training on your WaterRower and to avoid unnecessary problems or injuries here are a few guidelines:

- A health check before starting an exercise program.
- Use heart rate to monitor your intensity.
- Always warm up and cool down.
- Always stretch, especially at the end of your workout.
- Keep a record of your workouts.
- Keep well hydrated.
- Gradually increase the intensity, duration and frequency of your workouts.
- Ensure you include recovery time in your training program.
- Add variety to your workouts (refer to [www.HowToRow.com/workouts](http://www.HowToRow.com/workouts)).

## TRAINING RESOURCES

---

For further information on your exercise objectives and rowing training types please visit [www.HowToRow.com](http://www.HowToRow.com).







We have done our best to keep the assembly instructions as clear and concise as possible. Assembling your WaterRower takes about 30-45 minutes and the only tool you need is a 5mm Allen key that is included on the rear spacer or in the assembly bag. The WaterRower comes partially assembled in two boxes.

**PLEASE READ INSTRUCTIONS FULLY BEFORE STARTING ASSEMBLY**

## COMPONENTS

### Main Parts

- A Mono Rail Assembly
  - i. Mono rail with seat
  - ii. Rear Leg with bungee
- B Tank Assembly
- C Sub Rails × 2
- D Footboard

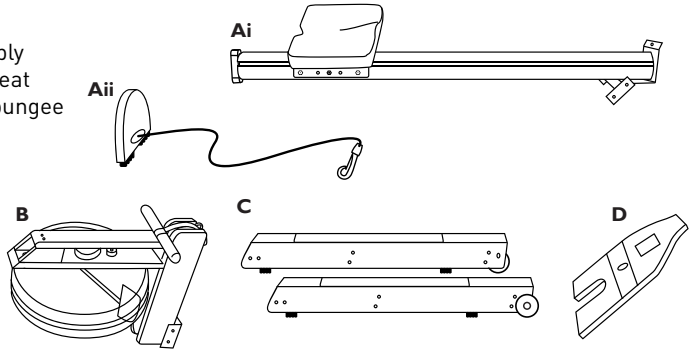

### Other Parts

- E JCB (WRB-B711) × 8
- F JCN (WRP-B700) × 8
- G Handle Rest (WRP-P430) × 2
- H Handle Rest Bolt (WRP-P455) × 2
- I Clamp Bar Bolt (WRP-P1140) × 1
- J Rail Sub Bracket Bolt (WRP-S201) × 1
- K\*\* Back of Footboard Bolt (WRP-B720) × 4
- L Rail Sub Bracket (WRP-R1500) × 1
- M 5mm Allen Key (WRP-B740) × 2
- N Footpads (WRP-P1700) × 2
- O Syphon Pump (WRP-B405) × 1
- P Purification Tablets (WRP-B960) × 2

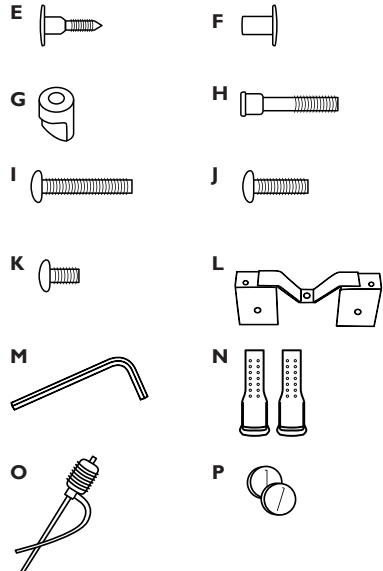

\*\*K Bolts are located on the back of footboard [see step 4]

## STEP 1

Using the Allen key (M) provided, remove block from monorail (Ai) and attach rear leg (Aii).

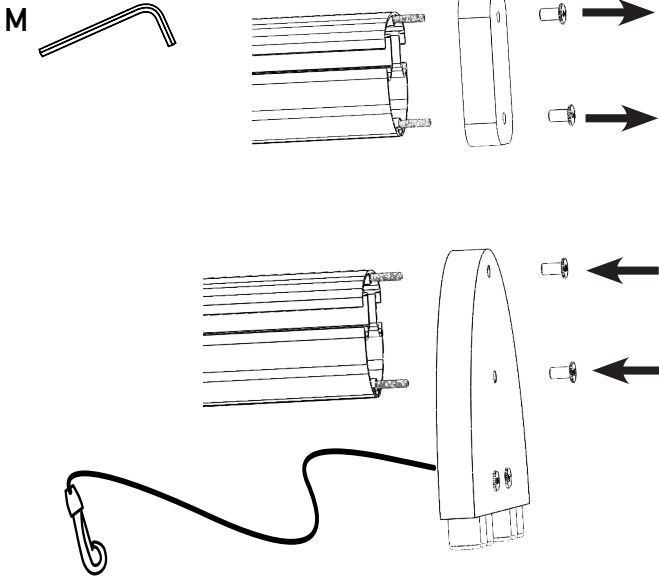

## STEP 2

Lay the sub rails on the floor with ends parallel. Dolly wheels on the outside.

Attach the end of the mono rail (A) to the angled ends of the sub rails (C) with the Allen key (M) and 4 pairs of the JCN nuts (F) and JCB bolts (E) .

Do not tighten all the way.

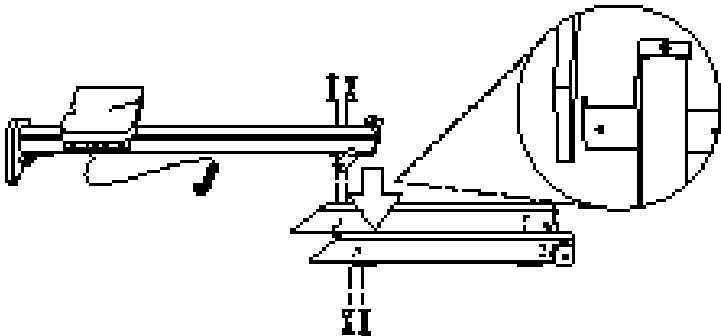
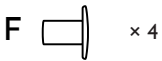
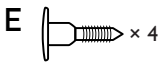

### STEP 3

Place the tank assembly (B) on the sub rails (C) in the direction shown in the picture below.

Using the Allen key (M) and 4 pairs JCN nuts (F) and JCB bolts (E), attach the forward riser bracket to the rails. You may need to apply slight pressure to align bracket and rail holes. May have to loosen top four front foward riser bolts. Do not tighten all the way.

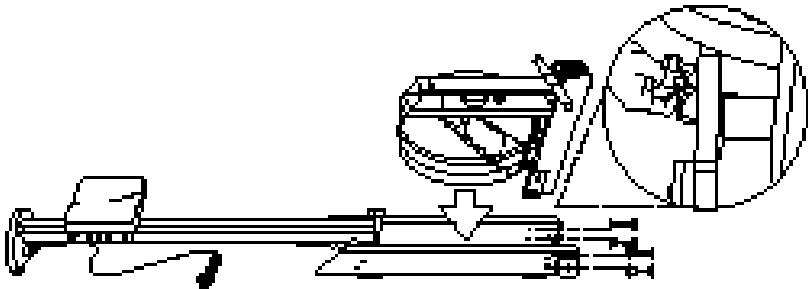
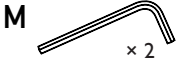

### STEP 4

First remove the back of Footboard Bolts (K) from behind the footboard. These bolts are used in steps 7 and 9.

Place the footboard on the rails, then attach the sensor cable to the monitor cable protruding from the back of the footboard.

The sensor cable may be taped to the back of the footboard. If so, remove the tape.

Feed the cable gently through the brackets so it does not get trapped between the footboard and tank assembly.

Align gold rivnuts on the tank assembly with the footboard's handle rest holes.

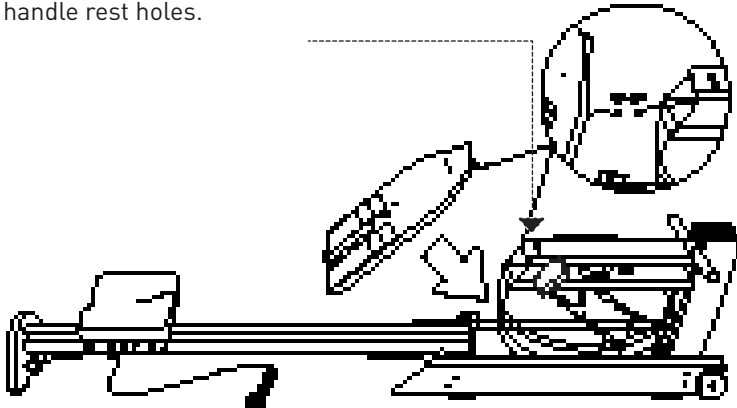
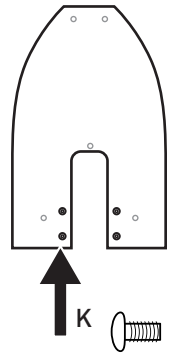

## STEP 5

Using the 5mm Allen key (M), screw the handle rests and bolts (G & H) through the top of the footboard into the rivnuts mentioned in the previous step.

Do not over tighten these bolts.

\*If you loosened the Top Deck Bolts in step 4 to align the footboard, first tighten them before tightening the handle bolts.

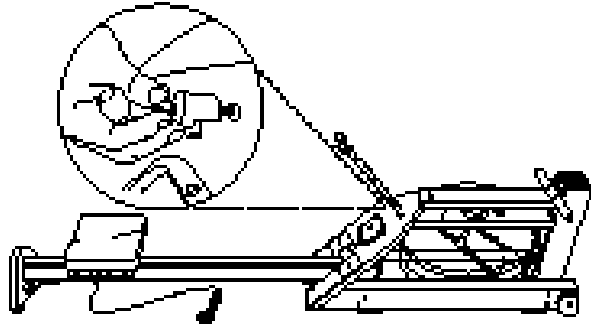
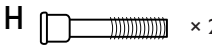

## STEP 6

Tighten the footboard to the mono rail by screwing in the clamp bar bolt (I).

You may need to lift the rail. Do not tighten all the way.

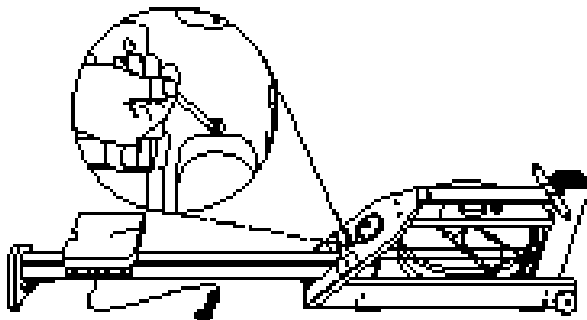
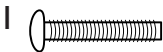



## STEP 7

Stand the machine up. Insert 2 of the Back of Footboard Bolts (which were removed in step 4) into the footboard bracket and tighten.

Having kept all the bolts loose will allow easier alignment of the bolts and rivnut holes in the footboard.

Do not tighten all the way.

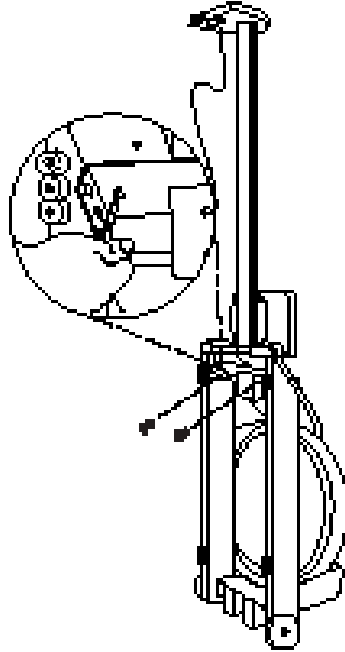
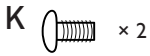
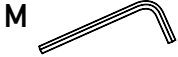

## STEP 8

Insert the sub bracket bolt (J) through the “U” in the rail sub bracket (L) into the rail, to hold the bracket in place for step 9.

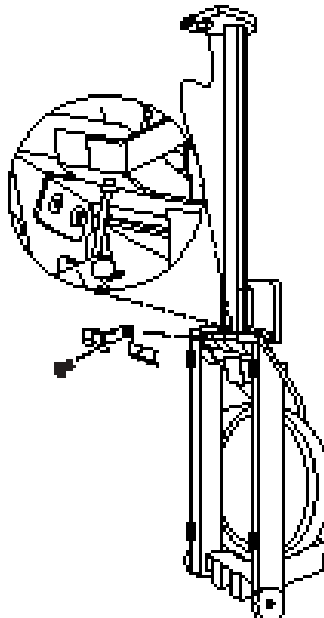
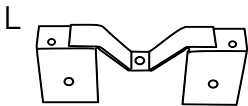
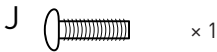

## STEP 9

---

Screw in the rail sub bracket (L) underneath the footboard using the 2 remaining back of footboard bolts (K).

M

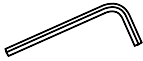

K



× 2

L

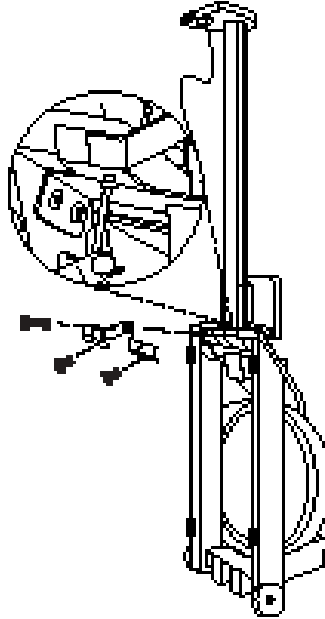
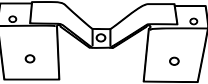

## STEP 10

---

Tighten the rail sub bracket bolt (J) (Step 8) firmly in place. Tighten everything.

M

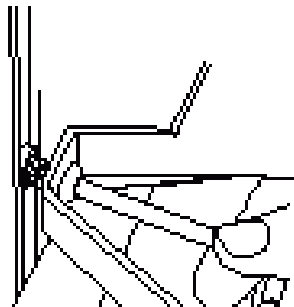
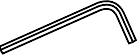

## STEP 11

---

Unwrap the recoil belt from the forward riser bracket, making sure the belt runs below and around the pulley.

Attach the D ring on the recoil belt to the bungee hook.

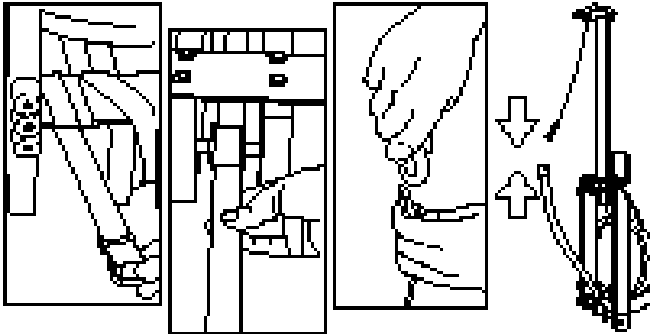

## STEP 12

---

Lay the unit flat and remove the tank stopper from between the top and bottom deck. Use the included syphon pump (O) to fill the tank to the level indicated on the level gauge sticker located on the underside of the tank. (See next page.)

Do not fill above the 19 level mark.

Insert one purification tablet (P) every six months. Additional purification tablets are available upon request at: [www.waterrowerservice.com/puritabs](http://www.waterrowerservice.com/puritabs)

Moisten the tank stopper to assist with replacement.

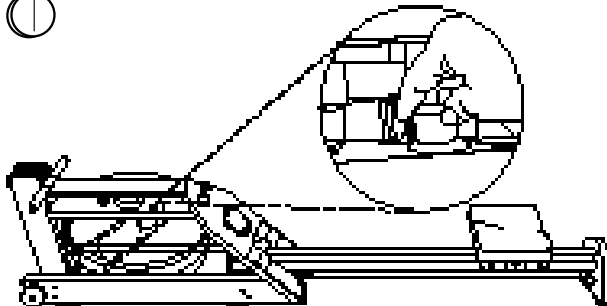
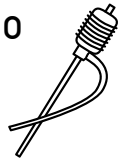

## STEP 13

---

Go back and tighten all the bolts in steps 2, 3, 6 and 7.

Should you experience any problem with aligning the components, loosen all bolts, align and retighten.

## HOW TO FILL AND EMPTY THE TANK

---

- 1) To pump water, turn the knob clockwise to close valve as shown in figure A
- 2) Locate water source above (higher than) water destination:
  - See Figure B for filling tank
  - See Figure C for emptying tank
- 3) Squeeze pump 4-5 times until water flows
- 4) Turn knob counter-clockwise to allow air into the pump and end syphon.

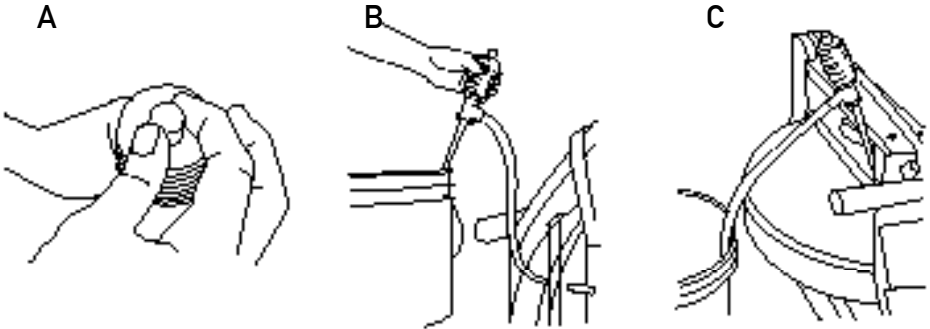

## THE LEVEL GAUGE

---

The Level Gauge is positioned underneath the tank; to locate the Level Gauge sticker stand the machine up and look between the two wooden sub rails.

Information on the sticker includes the Serial Number, WaterRower contact information and the Water Level Gauge. The standard Calibration Level is Level 17. The maximum level to fill the tank is Level 19 - **DO NOT** fill above this level. Doing so could void your warranty.

It is recommended that all machines in a group class setting are filled to Level 17, this is to ensure all users are in the 'same boat', and race times remain accurate and consistent.

Recommended Water Level is Level 17

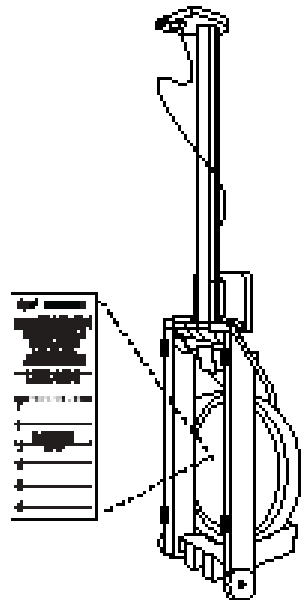





### INTRODUCTION

The WaterRower A1 Monitor has been designed to balance function with user friendliness.

The WaterRower A1 Home Monitor Display consists of 4 information windows, 2 select buttons and 3 navigation buttons.

Display Windows Include:

- A** INTENSITY - Shows the intensity of exercise in various units
- B** STROKE RATE - Shows the number of strokes per minute
- C** DISTANCE - Shows the distance covered in various units
- D** TIME - Shows the duration of exercise in time

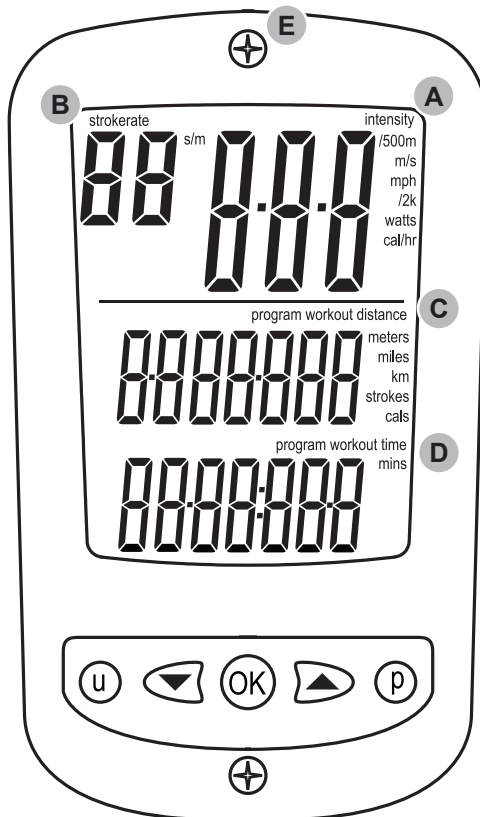

## STARTING INFORMATION

---

Please press the **OK** button to turn on the monitor. The four information windows will read zeros and be in Ready Mode. The monitor will commence monitoring as soon as you begin rowing.

Note: The monitor will turn off automatically after about 2 minutes of no use.

## INFORMATION WINDOWS

---

### A) INTENSITY WINDOW

The Intensity Window of the WaterRower A1 Home Monitor displays speed in units of time/500m (minutes per 500 meters), m/s (meters per second), mph (miles per hour), and /2km (minutes per 2 kilometers). It also displays power in watts, and energy consumption in cal/hr (calories burnt per hour). See "Setting Units" later in this manual to select desired units

### B) STROKE RATE WINDOW

The Strokerate Window of the WaterRower A1 Home Monitor displays strokerate (number of strokes rowed per minute) in units of strokes/min (strokes per minute).

### C) DISTANCE WINDOW

The Distance Window displays the distance covered in units of meters, miles, km (kilometers), strokes or cals (calories burnt). See "Setting Units" later in this manual to select desired units. The Distance Window will also display the distance remaining when doing a distance workout. See Setting Workouts- Distance Workouts later in this manual to set a distance workout

### D) TIME WINDOW

The Time Window displays the time covered in units of hours, minutes, and seconds. The Time Window may also be programmed to display time remaining. See Setting Workouts -Time Workouts later in this manual to set a time workout.

**Battery Replacement** - To replace the batteries, unscrew the two screws on the top and bottom of the monitor (Ⓜ) with a Phillips head screwdriver. Carefully remove the monitor and lift the inset battery pack out of the foot board. The monitor is powered by two AA batteries.

## SETTING UNITS

---

Display units may be changed by pressing the **U** button. Press the **U** button once to change intensity units and again to change distance units.

### INTENSITY UNITS

Press the **U** button until only the intensity digits appear along with the list of intensity units (see image below).

Using the **ARROW** buttons, scroll to the desired intensity unit (l/500m, m/s, mph, /2km, watts or cal/hr). Once the desired unit is flashing, press **OK** and the monitor will return to Ready Mode.

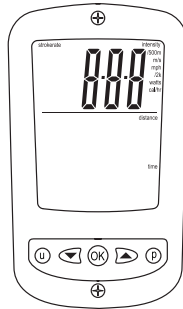

### DISTANCE UNITS

Press the **U** button until only the distance digits appear along with the list of distance units (see image below).

Using the **ARROW** Buttons, scroll to the desired distance unit (meters, miles, km, strokes, or cal/s). Once the desired unit is flashing, press **OK** and the monitor will return to Ready Mode.

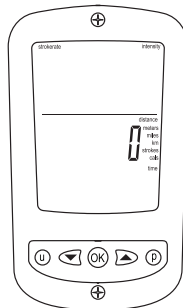



## SETTING WORKOUTS

---

Workouts may be set by pressing the **P** button. Press the **P** button once to set Distance Workouts and again to set Time Workouts.

### DISTANCE WORKOUTS

Press the **P** button until only distance digits appear along with Program Workout Distance flag (see image below) with the distance units flashing.

Using the **ARROW** Buttons, scroll to the desired workout distance. The **UP ARROW** Button increases the distance by 50 meters while the **DOWN ARROW** Button decreases the distance by 10 meters. Holding either button accelerates scrolling.

Once the desired workout distance is reached press **OK** and the monitor will return to Ready Mode with the set distance in the Distance Window. When rowing starts, distance will count down.

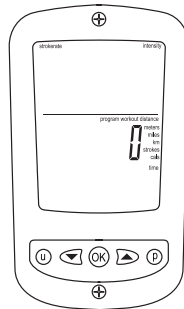

### TIME WORKOUTS

Press the **P** button until only the time digits appear along with Program Workout Time (see image below) with the time units flashing.

Using the **ARROW** Buttons, scroll to the desired workout duration. The **UP ARROW** Button increases the time by 1 minute while the **DOWN ARROW** Button decreases the time by 10 seconds. Holding either button accelerates scrolling.

Once the desired workout duration is reached press **OK** and the monitor will return to Ready Mode with the set time in the Time Window. When rowing starts, time will count down.

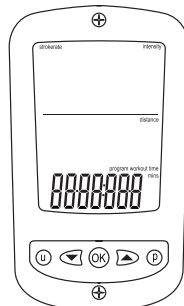

## LIMITED WARRANTY

---

**What This Limited Warranty Covers:** In-Home and Commercial Use - WaterRower (US) Inc. ("WaterRower") will replace or repair at its factory or nominated service facility any WaterRower Rowing Machine ("the Product") found to be defective in material or workmanship for a period of ONE (1) YEAR from the date of initial shipment of the Product by WaterRower. This Limited Warranty is upgradeable to THREE (3) YEARS on all components, excluding touchscreen electronics, electronics accessories and rechargeable batteries, and FIVE (5) YEARS on the structural frame by registering the Product within the first year of purchase.

**WaterRower warrants against defects in material or workmanship for touchscreen electronics, electronics accessories and rechargeable batteries received from WaterRower or any of its authorized dealers for a period of ONE (1) YEAR after the date of shipment.**

WaterRower warrants against any replacement WaterRower spare part received from WaterRower or any of its authorized dealers for a period of NINETY (90) DAYS after the date of shipment.

This Limited Warranty applies to the initial purchasers of the Product or spare part and is not transferable to any other party.

**How Can a Customer Obtain Warranty Service:** A customer making a warranty claim is responsible to return the defective Product or component to WaterRower's factory or its nominated service center, prepaying all postage or other shipping charges. The Product or component must be returned to your nearest WaterRower office or nominated service center (<https://www.waterrower.com/contact-us>). The customer must first notify WaterRower of his/her intent to return the Product or component and receive a confirmation from WaterRower before the Product is returned.

**Claimant's Responsibilities:** A claimant must ensure that the defective Product or component are properly packed to protect it from damage during shipping. WaterRower will not be responsible for any damage that occurs to the Product or component during shipment.

**What WaterRower Will Do:** WaterRower, will review, repair or replace the Product or component at WaterRower's discretion. WaterRower will then return the repaired or replaced Product or component to the claimant at WaterRower's expense. WaterRower will ground/economy ship all replacement warranty Products or components to claimant. Charges will apply for any alternative shipping methods requested by claimant. Product shipped outside of its initial purchase country may be subject to additional shipping costs. Where the product warranty has been deemed void, the costs of repair and any associated shipping costs shall be borne by the claimant. WaterRower will contact the claimant prior to return of the repaired Product or component.

**This Limited Warranty Will be Void When:** This Limited Warranty will be void if the claim has resulted from: (a) improper assembly of the Product, (b) usage of the Product beyond its design, (c) overfilling of the Product's water tank, as explained in the WaterRower Assembly Manual, (d) use of a purification product in the water tank other than that which has been approved by WaterRower, (e) use of improper cleaning materials, as described in the preventative maintenance steps in the WaterRower Owner's Manual, (f) use and/or storage of Product in inclement weather, including but not limited, to extreme temperatures and moisture; (g) accident, abuse, misuse, misapplication or as a result of any modification other than that authorized by WaterRower, and (h) improper preventative maintenance steps as described in the WaterRower Owner's Manual.

**Restriction on the Duration of Implied Warranties:** The term of any implied warranty, including but not limited to any implied warranty of merchantability or fitness for a particular purpose that may arise under your country province or state law is limited to the term of the express Limited Warranty in the first paragraph, above. Some states (countries and provinces) do not allow limitations on how long an implied warranty lasts, so the above limitation may not apply to you.

**Restriction on Other Damages:** WaterRower shall not be liable for any direct, consequential, incidental, indirect or special damages under this Limited Warranty or any implied warranty that may arise under your country, province or state law. Some states (countries and provinces) do not allow the exclusion or limitation of incidental or consequential damages, so the above limitation or exclusion may not apply to you.

Any dispute arising from the terms of this Limited Warranty must be resolved in a court within the state of Rhode Island, USA.

Additional information on parts, assembly, preventative maintenance and manuals, as referred to within this Limited Warranty, can be found at [www.waterrower.com/warranty](http://www.waterrower.com/warranty)

## **TROUBLESHOOTING TIPS**

---

1. Loosening bolts - over time and with use bolts can come loose, use the 5mm Allen key to gently tighten the bolts. If the bolts continue to loosen use a small amount medium strength Loctite® to fasten the nuts and bolts more securely.
2. Monitor not turning on - check the batteries positioned behind the monitor. Unscrew the monitor and gently lift to access the battery pack.
3. Monitor not counting down - check the monitor and sensor connector is connected. Check all wiring is intact.
4. Paddle not turning smoothly, loosen all tank bolts and retighten.

For other troubleshooting and service tips, please visit:  
[www.waterrowerservice.com](http://www.waterrowerservice.com)  
or contact WaterRower at [support@waterrower.com](mailto:support@waterrower.com)

Make note of the serial number. This number can be found on the level gauge sticker and is required when contacting WaterRower for customer support.

**S/N<sup>o</sup>:** \_\_\_\_\_

If you have any questions or comments about the assembly or use of this unit, please contact [support@waterrower.com](mailto:support@waterrower.com) or the phone numbers on the back of this booklet.



UNITED STATES | [www.waterrower.com](http://www.waterrower.com)  
560 Metacom Avenue | Warren, RI 02885  
Tel: +1 (401) 247 7742 | [info@waterrower.com](mailto:info@waterrower.com)

UNITED KINGDOM | [www.waterrower.co.uk](http://www.waterrower.co.uk)  
19 Acton Park Estate | The Vale, London W3 7QE  
Tel: +44 (0)20 8749 9090 | [info@waterrower.co.uk](mailto:info@waterrower.co.uk)

AUSTRALIA | [www.waterrower.com.au](http://www.waterrower.com.au)  
72 South Street | Rydalmere NSW 2116 Australia  
Tel: +61 (0) 2 9898 1405 | [info@waterrower.com.au](mailto:info@waterrower.com.au)

WRM7220 Rev H 123119